

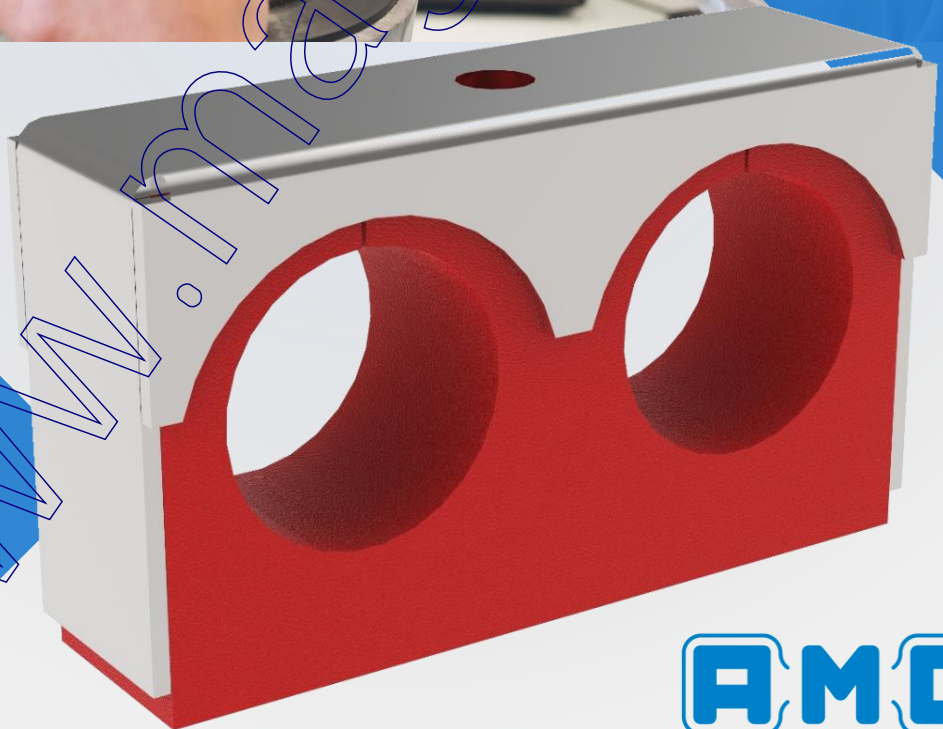

AKUSTIK PIPE  
AMC MECANOCAUCHO®

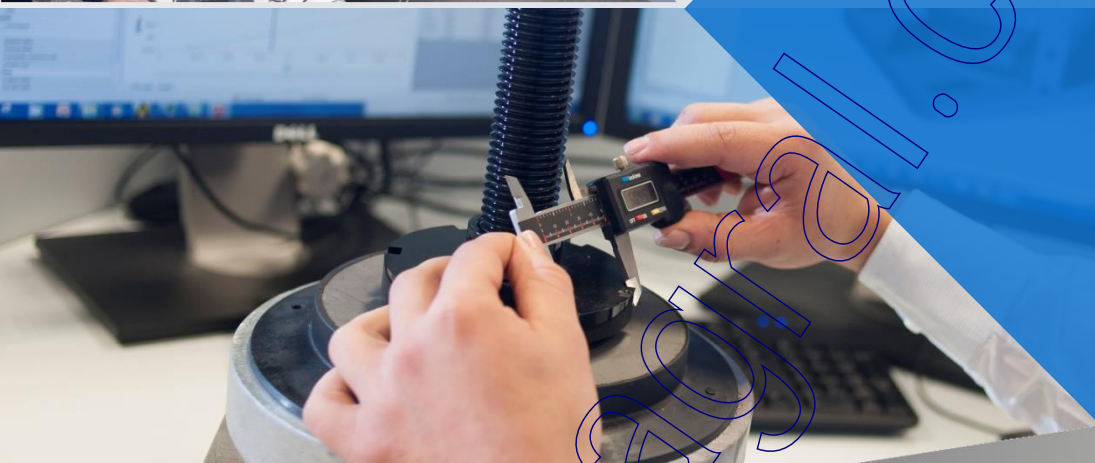

**AMC**  
MECANOCAUCHO  
by getzner  
sylomer®

# AKUSTIK PIPE

## DESCRIPTION

AMC-MECANOCAUCHO® Akustik Pipe consist in a double-hole Sylomer part enclosed in a steel housing.

The assembly of this mounting is very simple due to the easily removable Sylomer part and its single fastening hole. The uncovered distance by the housing determines the preload of the Akustik Pipe, allowing the bolt to be tightened until the housing is firmly in contact with the base.

AMC-MECANOCAUCHO® Akustik Pipes are specially suitable for applications where rigid or flexible pipes must be isolated, both for static and dynamic applications.

Moreover, these mounts assure the stability of the suspended pipes by limiting the radial deflection that can be achieved in any direction.

The materials in which these mounts are made protect the Akustik Pipes against aging and corrosion.

## ADVANTAGES:

- Compact design
- Fail-safe feature
- Multidirectional mount
- Excellent noise isolation
- Corrosion resistant
- Maintenance-free
- No aging

## APPLICATIONS:

- Construction machinery
- Mining equipment
- Buses
- HVAC equipment
- Hydraulic equipment

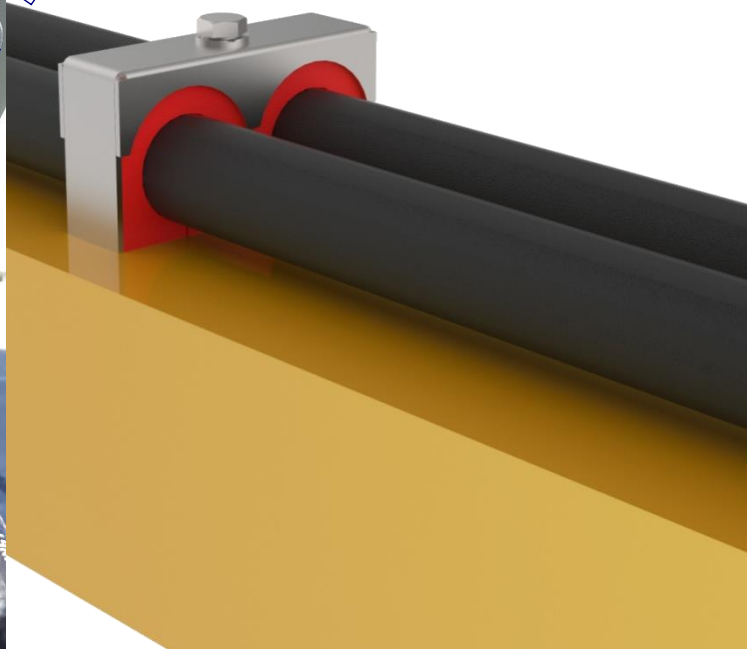

# TECHNICAL CHARACTERISTICS

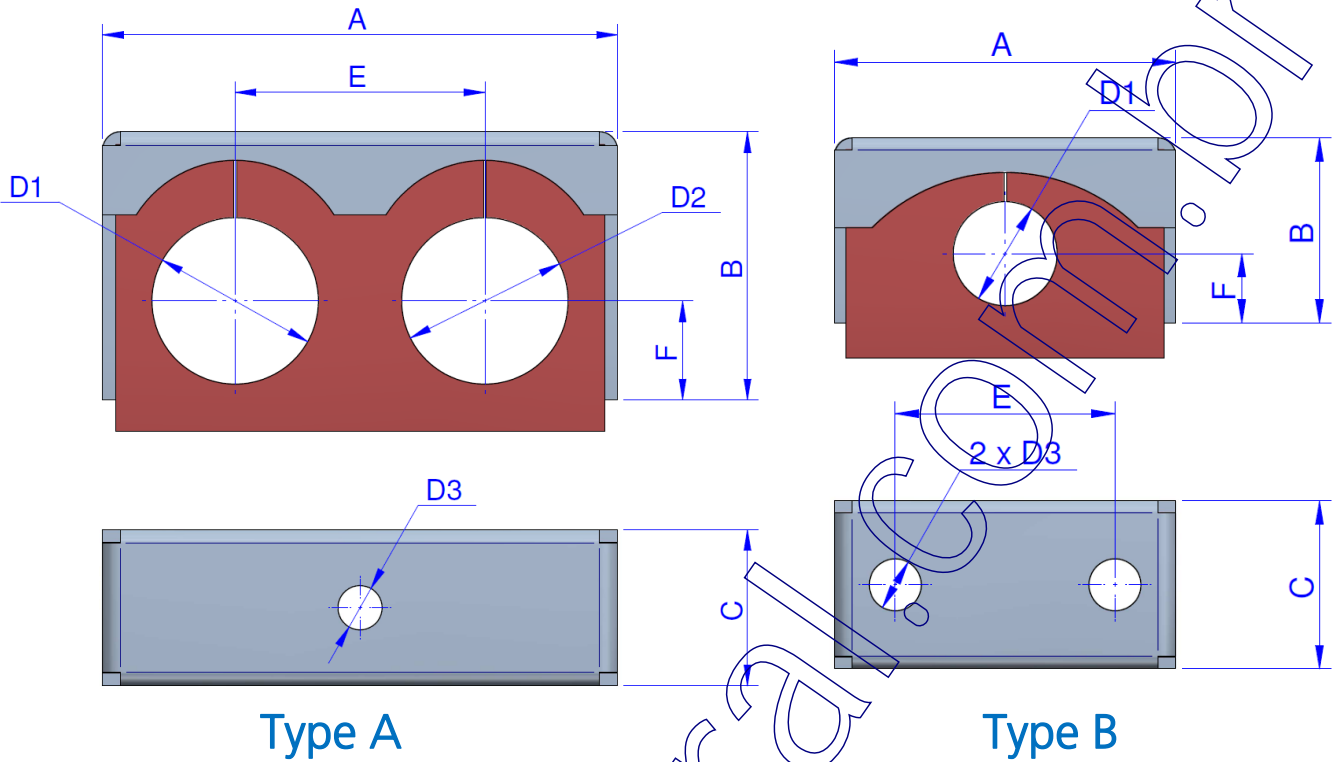

Code	Description	Type	A	B	C	D1	D2	D3	E	F
23872	AKUSTIK PIPE Ø15 / Ø18	A	70	38	29	15	18	8,5	36	15
23873	AKUSTIK PIPE Ø18	A	70	38	29	18	18	8,5	36	15
23874	AKUSTIK PIPE Ø21,2 / Ø24,3	A	82	42	29	21,2	24,3	8,5	43	15
23871	AKUSTIK PIPE Ø22	A	70	38	29	22	22	8,5	36	13
23876	AKUSTIK PIPE Ø28	A	98	53	29	28	28	8,5	48	21
23875	AKUSTIK PIPE Ø32	A	98	53	29	32	32	8,5	48	21
23877	AKUSTIK PIPE 1x Ø18	B	59	32	29	18	-	9	38	12



**DEMONSTRATION VIDEO**

# ELASTIC PROPERTIES

LOAD-DEFLECTION

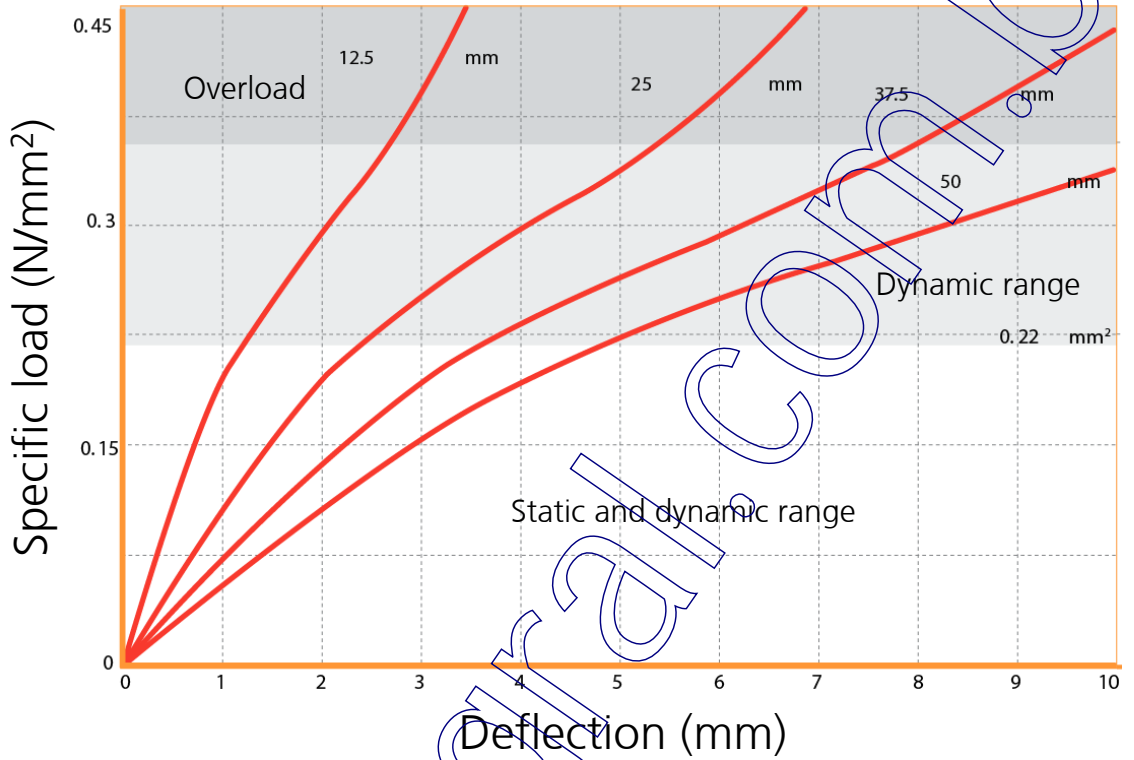

NATURAL FREQUENCY

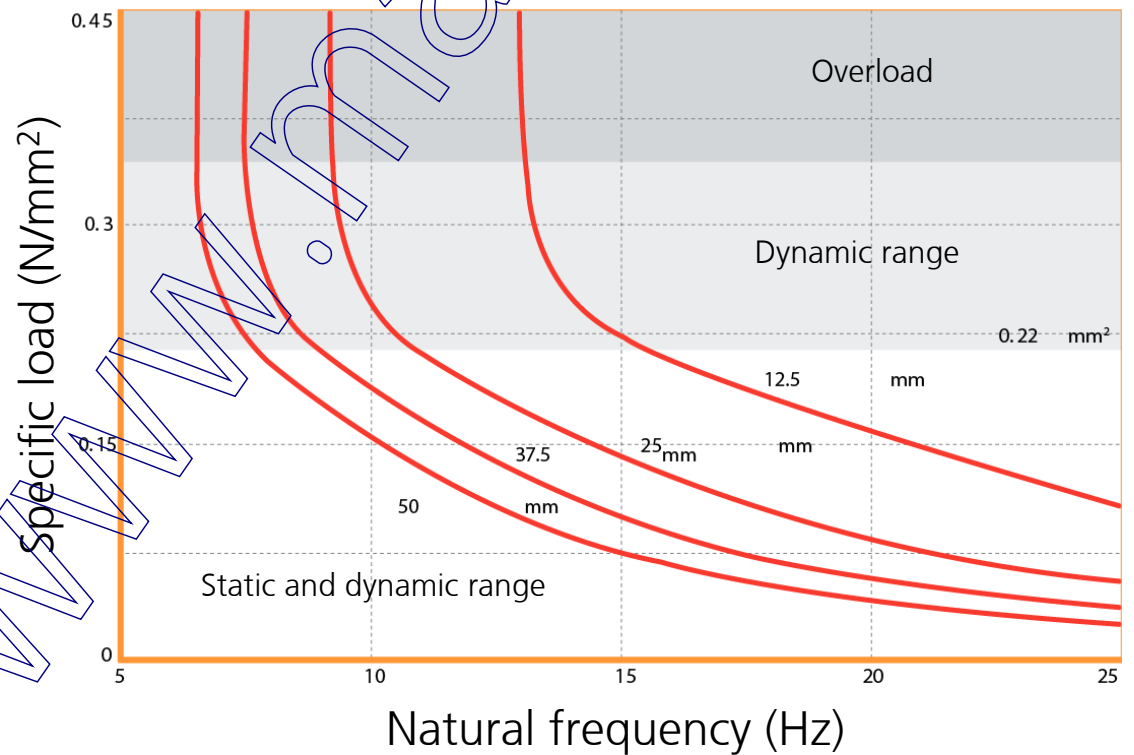

CUSTOM MADE SOLUTIONS AVAILABLE  
UPON REQUEST

REINFORCED HOUSINGS

LIGHT HOUSINGS

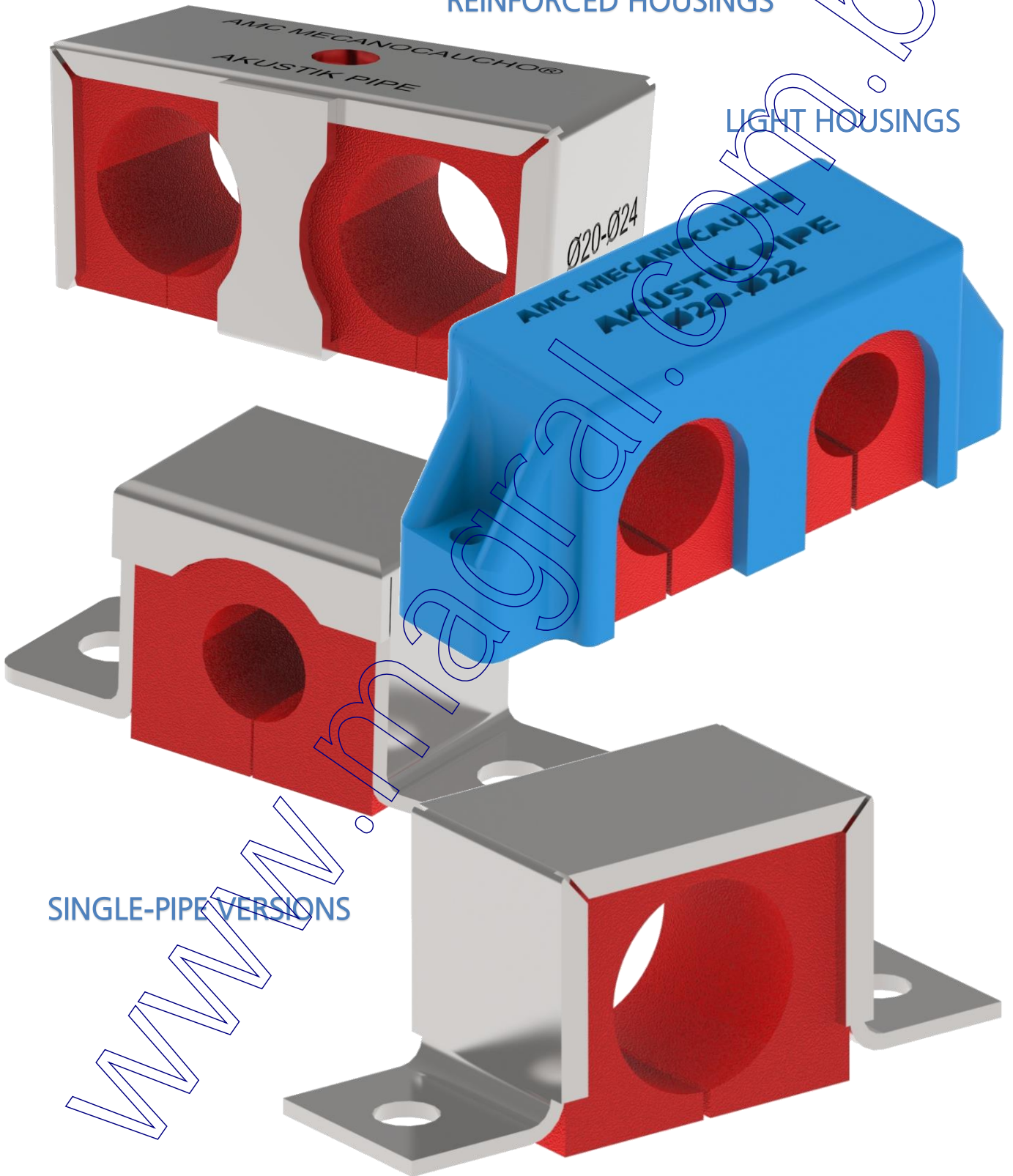

SINGLE-PIPE VERSIONS

[www.magral.com.br](http://www.magral.com.br)



Aplicaciones Mecánicas del Caucho S.A.  
Industrialdea Parc. 35 A. • E-20.159  
ASTEASU (Gipuzkoa) Spain  
Tel.: + 34 943 69 61 02 • Fax: + 34 943 69 62 19  
e-mail: [sales@amcsa.es](mailto:sales@amcsa.es)  
[www.akustik.com](http://www.akustik.com)  
[www.mecanocaucho.com](http://www.mecanocaucho.com)