



# Industrial Mechanical Pressure Gauges



Precision you can trust

# Index

Selection Guide ..... 3  
 Industrial Mechanical Pressure Gauges ..... 4  
 Ordering Information ..... 27  
 Dial Range Ordering Codes ..... 28  
 Optional Ordering Codes ..... 29  
 Accessories ..... 30



**IMPH**  
series  
Heavy Duty  
Page 7



**IMPG**  
series  
General Use  
Page 11



**IMPS**  
series  
Safety Pattern/  
Solid Front  
Page 15



**IMPP**  
series  
Process Gauge  
Page 19



**IMPL**  
series  
Low Pressure  
Page 23

## HAM-LET Pressure Gauges Process Connections



BSP-P Thread



NPT Thread



HAM-LET  
Tube Adapter



HAM-LET Face Seal  
Male Swivel



HAM-LET Face Seal  
Female Swivel

## HAM-LET Pressure Gauges Selection Guide

Series	Type	Configuration			Liquid Fillable	Solid Front	Safety Glass Window	Adjustable Pointer	Accuracy	Case Size	Measurement Range
		C	B	L						mm (inch)	
Heavy Duty	<b>H</b>	Yes	-	Yes	Yes	-	Yes	-	1.6% ± EN 837 Class 1.6 (Class 2.5 for 0-600 & 0-1000 bar range)	40 (1.5)	Vacuum: -1 - 0 bar Pressure: 0 - 600 bar
		Yes	Yes	Yes	Yes	-	Yes	Yes		63 (2.5)	Vacuum: -1 - 0 bar Pressure: 0 - 1000 bar
		-	Yes	Yes	Yes	-	Yes	Yes	1.0% ± EN 837 Class 1.0	100 (4)	
		-	Yes	Yes	Yes	-	Yes	Yes		160 (6)	
General Use	<b>G</b>	Yes	-	Yes	Yes	-	-	-	± 1.6% EN 837 Class 1.6 (Class 2.5 for 0-600 & 0-1000 bar range)	50 (2)	Vacuum: -1 - 0 bar Pressure: 0 - 600 bar
		Yes	Yes	Yes	Yes	-	Yes	-		63 (2.5)	Vacuum: -1 - 0 bar Pressure: 0 - 1000 bar
		-	Yes	Yes	Yes	-	Yes	-	± 1.0% EN 837 Class 1.0	100 (4)	
Safety Pattern / Solid Front	<b>S</b>	-	Yes	Yes	Yes	Yes	Yes	Yes	± 1.6% EN 837 Class 1.6 (Class 2.5 for 0-600 & 0-1000 bar range)	63 (2.5)	Vacuum: -1 - 0 bar Pressure: 0 - 1000 bar
		-	Yes	Yes	Yes	Yes	Yes	Yes	± 1.0% EN 837 Class 1.0	100 (4)	
		-	-	Yes	Yes	Yes	Yes	Yes		160 (6)	
Process	<b>P</b>	-	-	Yes	Yes	Yes	Yes	Yes	± 0.5% ASME B40.1 Grade 2A	115 (4.5)	Vacuum: -1 - 0 bar Pressure: 0 - 1000 bar
Low Pressure	<b>L</b>	Yes	-	Yes	Yes	-	Yes	-	± 1.6% EN 837 Class 1.6	63 (2.5)	Vacuum: -25 - 0 mbar Pressure: 0 - 600 mbar
		Yes	-	Yes	Yes	-	Yes	Yes		100 (4)	

# Industrial Mechanical Pressure Gauges

## Bourdon Tube Measuring Element



Coiled type



C type

## General

The Industrial Mechanical Pressure gauges are measuring devices constructed from high quality materials, by the highest quality standards and methods.

The IMP gauge guarantees long life with durability for in-door and out-door industrial, process and instrumentation applications.

💡 The IMP product variety in the catalog covers standard gauge extensive options are available.

## Features

- Nominal case sizes: 40, 50, 63, 100, 115, 160 mm (1½", 2", 2½", 4", 4½", 6")
- Pressure, Vacuum and Compound measuring ranges
- Pressure ranges of
  - 0-1 inH<sub>2</sub>O up to 0-250 inH<sub>2</sub>O (0-2.5 mbar up to 0-600 mbar),
  - 0-10 up to 0-15,000 psi (0-0.6 up to 0-1000bar) and above
- Accuracy of ± 0.5/1/1.6/2.5 % of span (EN 837-1 Class 1/1.6/2.5, ASME B40.1 Grade 1A/2A /B/C)
- Manufactured in accordance to EN 837 and ASME B40.1 standards
- All wetted parts made of 316L Stainless Steel (Alloy 400 as an option)
- Connections include threaded, tube adapter and face seal

## Cleaning

Special cleaning of wetted part is available upon request -

- Lubricants free
- Silicon free
- Cleaned for Oxygen service

## Testing & Calibration

All IMP gauges are factory calibrated and bubble tested for leakage.  
Helium leak test is available.

## Selecting Pressure Gauge for Your Application

Selecting the proper gauge to withstand application pressures, temperature, media chemical effects and environmental conditions is a prime concern for the system engineer. The EN 837-2 or ASME B40.1 standard should be considered as guidelines for proper selection.  
For assistance in matching proper pressure gauge for your application, please consult HAM-LET local representative.

## Filling

Gauge cases are often liquid filled to protect the internals against damages caused by severe vibrations or pressure pulsations and exclude condensation in outdoor installations.  
All IMP gauges can be filled or unfilled as ordered, the gauges are always fillable.

- Standard filling is Glycerin (99%)
- Glycerin (86%) for low ambient temperatures, Silicon oil, other filling as an option

### Warning!

Glycerin and Silicon oil must be avoided where Oxygen or other strong oxidizing agents are present.

## Scale Selection and Load Limits

General recommendation for working measured pressure is to be in the range of 25-65% for pulsating pressures and 25-75% for steady pressures out of the maximal dial range.

### Recommended Working Pressure Range

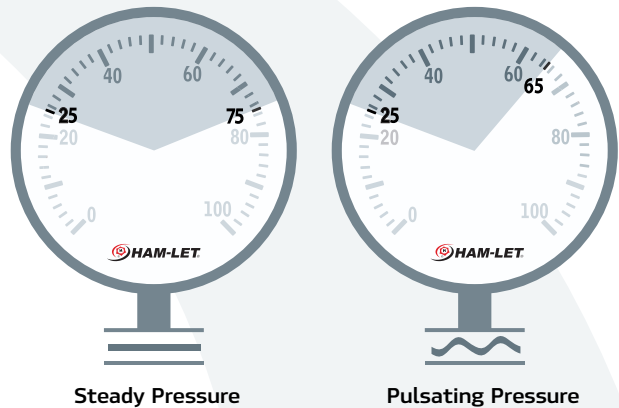

### Maximal pressure load limits for operation without loss of accuracy

Case size: 100, 115, 160 mm (4", 4½", 6")	
Type of load	Pressure load limit out of full scale
Steady	100%
Pulsating (cyclic)	90%
Overpressure (temporary)	130%

Case size: 40, 50, 63 mm (1½", 2", 2½")	
Type of load	Pressure load limit out of full scale
Steady	75%
Pulsating (cyclic)	65%
Over pressure (temporary)	100%

💡 The IMP gauges are constructed to withstand up to 300% full scale temporary over pressure without system failure.

💡 With low pressure gauges (L series) up to 1000% full scale over pressure protection can be supplied as an option.

## Process Connections

### Stainless steel process connections maximal pressure

Connection		Maximal Pressure
Type	Size	
BSP-P	1/8"	6,000 psi (400 bar)
NPT		
BSP-P	1/4"	15,000 psi (1,000 bar)
NPT		
Face Seal	1/4"	5,200 psi (359 bar)
NPT	1/2"	15,000 psi (1,000 bar)
BSP-P	1/2"	20,000 psi (1,600 bar)
HP		
Tube Adapter	1/4", 6mm	10,000 psi (600 bar)
	3/8", 1/2", 10 mm, 12mm	6,000 psi (400 bar)



## Temperature Limitations

Temperature Limitations	Unfilled	Glycerin (99%) Filled	Glycerin (86%) Low Temperature Filled
<b>Storage</b>	-40 to +158°F	-4 to +158°F	-4 to +158°F
	(-40 to +70°C)	(-20 to +70°C)	(-20 to +70°C)
<b>Ambient</b>	-40 to +140°F	-4 to +140°F	-40 to +140°F
	(-40 to +60°C)	(-20 to +60°C)	(-40 to +60°C)
<b>Media Max. H,G,S Series</b>	+392°F	+212°F	+212°F
	(+200°C)	(+100°C)	(+100°C)
<b>Media Max. P,L Series</b>	+212°F	+158°F	+158°F
	(+100°C)	(+70°C)	(+70°C)

## Reference Temperature

Measuring device is calibrated for working temperature of +68°F (+20°C).

0.4% deviation in the measured pressure for each +18°F (+10°C) temperature change should be expected.



For extreme ambient or media temperatures, please consult HAM-LET local representative.

### Warning!

The system designer and user have the sole responsibility for selecting products suitable for their special application requirements, ensuring their safe and trouble-free installation, operation, and maintenance. Application details, material compatibility and product ratings should all be considered for each selected product. Improper selection, installation or use of products can cause property damage or personal injury.



Heavy Duty  
Pressure Gauges

# IMPH series



HAM-LET Industrial Mechanical  
Pressure Gauges





# IMPH series

## Data Sheet

### General

The industrial mechanical **H**-Heavy duty pressure gauges series is designed for industrial, instrumentation and process applications that require long durability with accuracy and easy maintainability for indoor, outdoor and harsh environments.

The H series pressure gauges are a bourdon tube mechanical devices. Case sizes: 40, 63, 100, 160mm (1½", 2½", 4", 6") suitable for vacuum to pressure up to 1,000 bar (15,000 psi),

### Features

- All stainless steel case and wetted parts
- Bayonet ring and adjustable pointer for easy adjustment
- Safety laminated glass front
- Case is filled fillable dry
- Case protection: IP 65 (IP 54 for 160mm (6") case with range 30 psi (2.5 bar) and below)
- Safety category (EN 837-1) S1 for pressure gauges with blow-out device 100mm (4") and 63mm (2½") cases
- **Measuring Ranges**
  - Vacuum: 30" Hg Vac. to 0 psi (-1 to 0 bar)
  - Compound: 30" Hg Vac. through 0 to 300 psi (-1 through 0 to 15 bar)
  - Pressure: 0 to 15,000 psi (0 to 1,000 bar), 40mm (1½") case up to 10,000 psi (600 bar)

### Materials of Construction

Part		Material
<b>Wetted Parts</b>	Process connection	SS 316L
	Bourdon tube	
<b>Case</b>		SS 304
<b>Window</b>		Laminated safety glass
<b>Movement</b>		Stainless steel
<b>Dial</b>		Aluminum (black figures, white background)
<b>Pointer</b>		Aluminum (black)





## Technical Data - H Series

Case Size		40mm (1½")	63mm (2½")	100mm (4")	160mm (6")
Accuracy	Up to 6,000 psi (400 bar)	±1.6% of span EN 837-1 Class 1.6 ASME B40.1 Grade B	±1.6% of span EN 837-1 Class 1.6 ASME B40.1 Grade B	±1.0% of span EN 837-1 Class 1.0 ASME B40.1 Grade 1A	±1.0% of span EN 837-1 Class 1.0 ASME B40.1 Grade 1A
	10,000 psi (600 bar) and above <sup>(4)</sup>	±2.5% of span EN 837-1 Class 2.5 ASME B40.1 Grade C	±2.5% of span EN 837-1 Class 2.5 ASME B40.1 Grade C	±1.0% of span EN 837-1 Class 1.0 ASME B40.1 Grade 1A	±1.0% of span EN 837-1 Class 1.0 ASME B40.1 Grade 1A
Case Configurations	Process connection position				
	Mounting device (Optional)				
Process Connection	½", 12mm Tube adapter			+	
	3/8", 10mm Tube adapter	+ <sup>(1)</sup>	+		
	¼", 6mm Tube adapter	+	+		
	½" BSP-P/NPT			+	+
	¼" BSP-P/NPT	+ <sup>(1)</sup>	+	+	+
	1/8" BSP-P/NPT	+	+		
	M20x1.5			+	+
M12x1.5	+ <sup>(1)</sup>	+	+	+	
¼" face seal Male/Female swivel	+ <sup>(1)</sup>	+			
Blow-Out Device	Blow-out device at the top of the case				+
	Blow-out plug in the back of the case, Ø 40mm (1½")			+	
	Blow-out plug at the top of the case		+		
Case Ventilation	By blow-out device / Plug		+		+
	Internal pressure compensation by pressure equalizing membrane	+ <sup>(2)</sup>		+	
Weight <sup>(3)</sup> Pound (Kg.)	Unfilled	0.15 (0.07)	0.40 (0.18)	1.33 (0.60)	2.43 (1.10)
	Filled	0.22 (0.10)	0.55 (0.25)	2.10 (0.95)	4.30 (1.95)

(1) Center back mount only

(2) For pressure ranges up to 0-200 psi (0-16 bar)

(3) Approx. without mounting device

(4) See maximal pressure per connection type, page 6

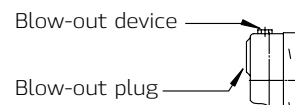

## Configuration and Mounting Dimensions

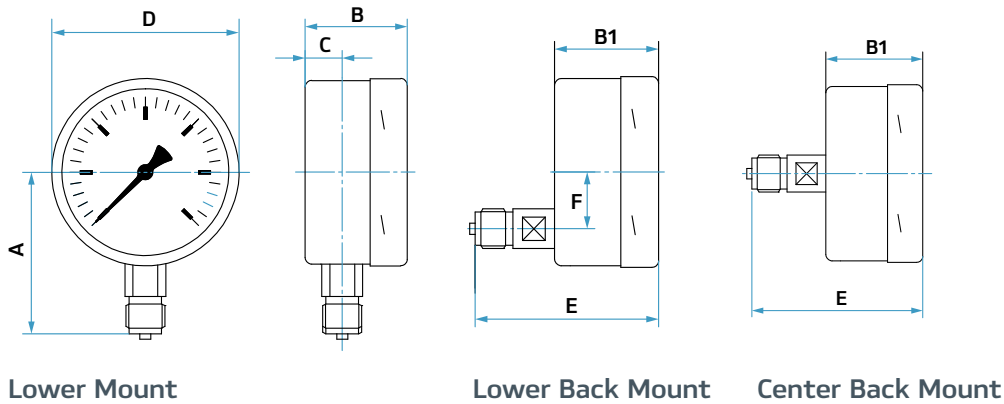

Case Size		A		B		B1		C		D		E		F	
mm	inch	mm	inch	mm	inch	mm	inch	mm	inch	mm	inch	mm	inch	mm	inch
40	1 ½	34.5	1.36	28	1.1	30	1.18	10	0.4	40	1.57	47	1.85	-	-
63	2 ½	54	2.13	33	1.3	37	1.46	10	0.39	64	2.52	59	2.32	18	0.71
100	4	87	3.43	55	2.17	55	2.17	20	0.79	101	3.98	97	3.82	30	1.18
160	6	115	4.53	51	2.01	51	2.01	15.5	0.61	161	6.34	92.5	3.64	30	1.18

### Back Flange Mounting

### Front Flange Mounting

### U-Clamp

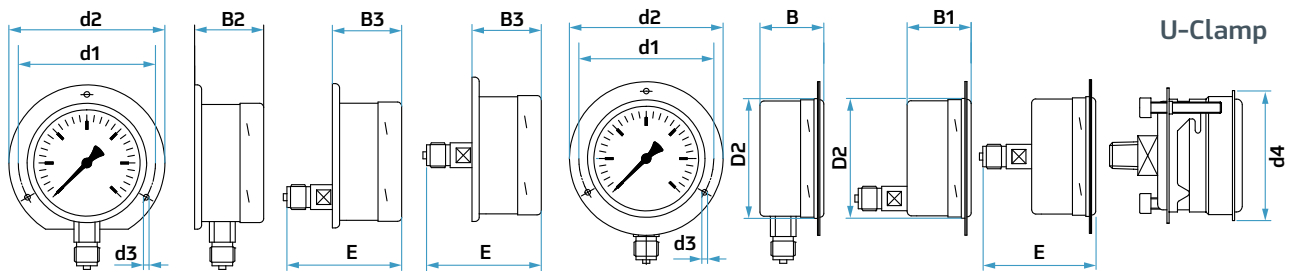

Case Size		B2		B3		D2		d1		d2		d3		d4	
mm	inch	mm	inch	mm	inch	mm	inch	mm	inch	mm	inch	mm	inch	mm	inch
40	1 ½	-	-	-	-	41.8	1.64	51	2.01	61	2.4	3.6	0.14	46	1.81
63	2 ½	36	1.42	40	1.57	66	2.6	75	2.95	85	3.35	3.6	0.14	-	-
100	4	58.5	2.3	58.5	2.3	103	4.06	116	4.57	132	5.2	4.8	0.19	-	-
160	6	54	2.13	54	2.13	163	6.42	178	7.01	196	7.72	5.8	0.23	-	-



General Use  
Pressure Gauges

# IMP G series



HAM-LET Industrial Mechanical  
Pressure Gauges



# IMP G series

## Data Sheet

### General

The Industrial **G** - General Use pressure gauges series guarantees long life and durability for indoor, outdoor and harsh surroundings, industrial, instrumentation and process applications.

The G series pressure gauge is a bourdon tube mechanical device, Case sizes 50, 63, 100, 160mm (2", 2½", 4", 6") suitable for vacuum to pressure up to 1.000 bar (15,000 psi).

### Features

- All stainless steel case and wetted parts.
- Polished Crimped-on ring for firm window sealing.
- Safety laminated glass front.
- Case is filled or fillable dry.
- Case protection: IP 65 (IP 54 for 160mm (6") case with range 30 psi (2.5 bar) and below).
- Safety category (EN 837-1) S1 for pressure gauges with blow-out device.
- **Measuring Ranges**
  - Vacuum: 30" Hg Vac. to 0 psi (-1 to 0 bar)
  - Compound: 30" Hg Vac. through 0 to 300 psi (-1 through 0 to 15 bar)
  - Pressure: 0 to 15,000 psi (0 to 1,000 bar), 50mm (2") case up to 10,000 psi (600 bar)

### Materials of Construction

Part		Material
<b>Wetted Parts</b>	Process Connection	SS 316L
	Bourdon Tube	
<b>Case</b>		SS 304L
<b>Window</b>		Laminated safety glass
<b>Movement</b>		Stainless steel
<b>Dial</b>		Aluminum (black figures, white background)
<b>Pointer</b>		Aluminum (black)



## Technical Data - G Series

Case Size		50mm (2")	63mm (2½")	100mm (4")	160mm (6")
Accuracy	Up to 6,000 psi (400 bar)	±1.6% of span EN 837-1 Class 1.6 ASME B40.1 Grade B	±1.6% of span EN 837-1 Class 1.6 ASME B40.1 Grade B	±1.0% of span EN 837-1 Class 1.0 ASME B40.1 Grade 1A	±1.0% of span EN 837-1 Class 1.0 ASME B40.1 Grade 1A
	10,000 psi (600 bar) and above <sup>(2)</sup>	±2.5% of span EN 837-1 Class 2.5 ASME B40.1 Grade C	±2.5% of span EN 837-1 Class 2.5 ASME B40.1 Grade C	±1.0% of span EN 837-1 Class 1.0 ASME B40.1 Grade 1A	±1.0% of span EN 837-1 Class 1.0 ASME B40.1 Grade 1A
Case Configurations	Process connection position				
	Mounting device (Optional)				
Process Connection	½", 12mm Tube adapter			+	
	3/8", 10mm Tube adapter	+	+		
	¼", 6mm Tube adapter	+	+		
	½" BSP-P/NPT			+	+
	¼" BSP-P/NPT	+	+	+	+
	1/8" BSP-P/NPT	+	+		
	M20x1.5			+	+
M12x1.5	+	+		+	
¼" face seal Male/Female swivel	+	+ <sup>(3)</sup>			
Blow-Out Device	Blow-out device at the top of the case				+
	Blow-out plug in the back of the case, Ø 40mm (1½")			+	
	Blow-out plug at the top of the case		+		
Case Ventilation	By blow-out device / Plug	+	+		+
	Internal pressure compensation by pressure equalizing membrane			+	
Weight <sup>(1)</sup> Pound (Kg.)	Unfilled	0.198 (0.09)	0.40 (0.18)	1.33 (0.60)	2.43 (1.10)
	Filled	0.286 (0.13)	0.55 (0.25)	1.98 (0.90)	3.75 (1.70)

(1) Approx. without mounting device

(2) See maximal pressure per connection type, page 6

(3) Center back mount only

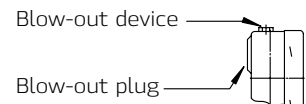

## Configuration and Mounting Dimensions

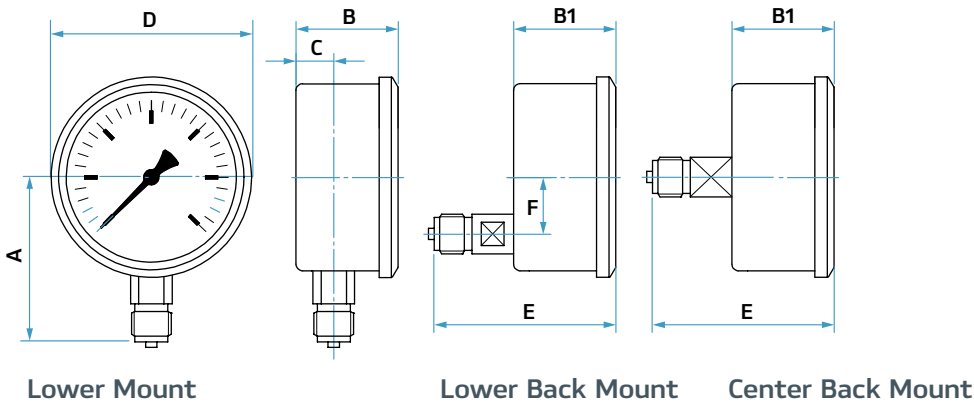
**Lower Mount**
**Lower Back Mount**
**Center Back Mount**

Case Size		A		B		B1		C		D		E		F	
mm	inch	mm	inch	mm	inch	mm	inch	mm	inch	mm	inch	mm	inch	mm	inch
50	2	45	1.77	29	1.14	31	1.22	10	0.4	54	2.13	50	1.97	-	-
63	2 ½	54	2.13	33	1.3	37	1.46	10	0.40	67	2.63	60	2.36	18	0.71
100	4	87	3.43	54	2.13	54	2.13	20	0.79	106	4.17	96	3.78	30	1.18
160	6	115	4.53	50	1.97	55	2.17	15	0.59	167	6.57	97	3.82	30	1.18

### Back Flange Mounting

### Front Flange Mounting

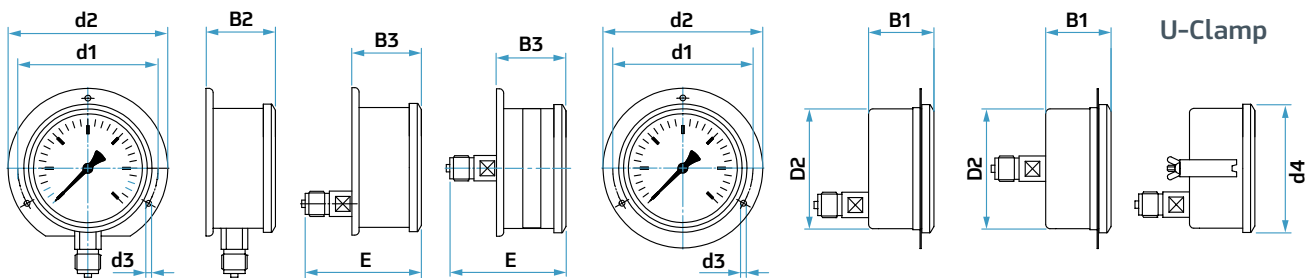

Case Size		B2		B3		D2		d1		d2		d3		d4	
mm	inch	mm	inch	mm	inch	mm	inch	mm	inch	mm	inch	mm	inch	mm	inch
50	2	-	-	-	-	51	2.01	60	2.36	71	2.8	3.6	0.14	71	2.8
63	2 ½	36	1.42	40	1.57	64	2.52	75	2.95	85	3.35	3.6	0.14	-	-
100	4	57.5	2.26	57.5	2.26	101	3.98	116	4.57	132	5.2	4.8	0.19	-	-
160	6	53	2.09	58	2.28	-	-	178	7.01	196	7.72	5.8	0.23	-	-



Safety Pattern / Solid Front  
Pressure Gauges

**IMP S**  
series



HAM-LET Industrial Mechanical  
Pressure Gauges



# IMPS series

## data sheet

### General

The Industrial S - Safety Pattern / Solid Front pressure gauges series is a heavy duty pressure gauge with special case and laminated safety glass window delivering a safer usage for the end system user while maintaining the long usability and durability for indoor, outdoor and harsh surroundings industrial, instrumentation and process applications. The Safety Pattern / Solid Front case has a break-proof solid front (firm partition between the pressure element and the window) and a pressure relief back (blow-out back). The S series gauges are marked with the Ⓢ symbol on the dial. The S series pressure gauge is a bourdon tube mechanical device, case sizes 63, 100, 160mm (2½", 4", 6") suitable for vacuum to pressure up to 1,000 bar (15,000 psi).

### Features

- All stainless steel case and wetted parts
- Bayonet ring and adjustable pointer for easy adjustment
- Break-proof solid front case with blow-out back
- Safety laminated glass front
- Case is filled or fillable dry
- Case Protection: IP 65
- Safety Category (EN 837-1) S3
- **Measuring Ranges**
  - Vacuum: 30" Hg Vac. to 0 psi (-1 to 0 bar)
  - Compound: 30" Hg Vac. through 0 to 300 psi (-1 through 0 to 15 bar)
  - Pressure: 0 to 15,000 psi (0 to 1,000 bar)





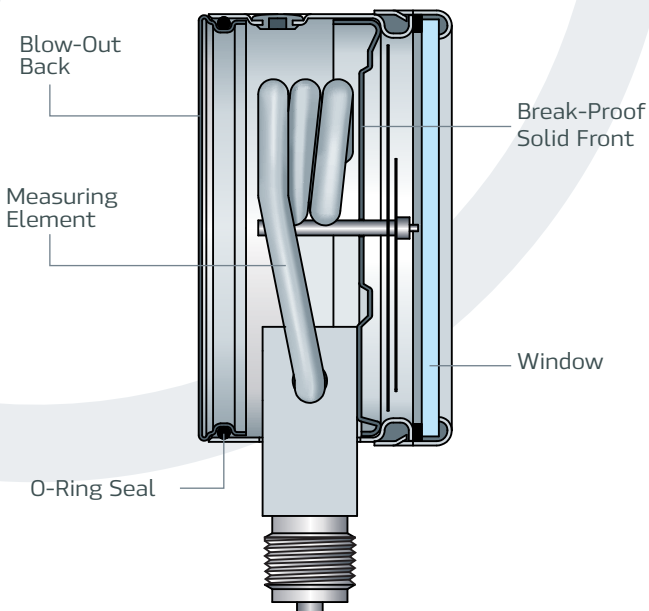

### Materials of Construction

Part		Material
<b>Wetted Parts</b>	Process Connection	SS 316L
	Bourdon Tube	
<b>Case</b>		SS 304L
<b>Window</b>		Laminated safety glass
<b>Movement</b>		Stainless Steel
<b>Dial</b>		Aluminum (black figures, white background)
<b>Pointer</b>		Aluminum (black)





## Technical Data - S Series

Case Size		63mm (2½")	100mm (4")	160mm (6")
<b>Accuracy</b>	<b>Up to 6,000 psi (400 bar)</b>	<b>±1.6% of span</b> EN 837-1 Class 1.6 ASME B40.1 Grade B	<b>±1.0% of span</b> EN 837-1 Class 1.0 ASME B40.1 Grade 1A	<b>±1.0% of span</b> EN 837-1 Class 1.0 ASME B40.1 Grade 1A
	<b>10,000 psi (600 bar) and above <sup>(2)</sup></b>	<b>±2.5% of span</b> EN 837-1 Class 2.5 ASME B40.1 Grade c	<b>±1.0% of span</b> EN 837-1 Class 1.0 ASME B40.1 Grade 1A	<b>±1.0% of span</b> EN 837-1 Class 1.0 ASME B40.1 Grade 1A
<b>Case Configurations</b>	<b>Process connection position</b>			
	<b>Mounting device (Optional)</b>			
<b>Process Connection</b>	½", 12mm Tube adapter		+	
	3/8", 10mm Tube adapter	+		
	¼", 6mm Tube adapter	+		
	½" BSP-P/NPT		+	+
	¼" BSP-P/NPT	+	+	+
	1/8" BSP-P/NPT	+		
	M20x1.5		+	+
M12x1.5	+	+	+	
<b>Blow-Out Device</b>	Blow-out back	+	+	+
	Screw with ventilation bore	+	+	+
<b>Case Ventilation</b>	Internal pressure compensation by pressure equalizing membrane	+	+	
<b>Weight <sup>(1)</sup></b> Pound (Kg.)	Unfilled	0.39 (0.18)	1.40 (0.65)	3.30 (1.50)
	Filled	0.55 (0.25)	2.20 (1.00)	6.5 (2.95)

(1) Approx. without mounting device

(2) See maximal pressure per connection type, page 6

(3) Lower back connection available only for dry option

## Configuration and Mounting Dimensions

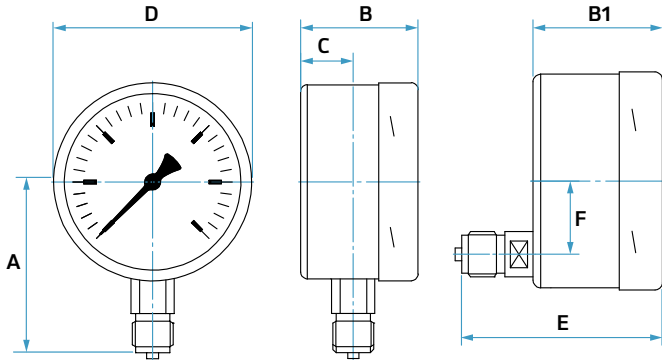
**Lower Mount**
**Lower Back Mount**

Case Size		A		B		B1		C		D		E		F	
mm	inch	mm	inch	mm	inch	mm	inch	mm	inch	mm	inch	mm	inch	mm	inch
63	2 1/2	54	2.13	41	1.61	41	1.61	18	0.71	64	2.52	63	2.48	18	0.71
100	4	87	3.43	60	2.36	60	2.36	27	1.06	101	3.98	93	3.66	34	1.34
160	6	115	4.53	78	3.07	78	3.07	40	1.57	161	6.34	-	-	-	-

### Back Flange Mounting

### Front Flange Mounting

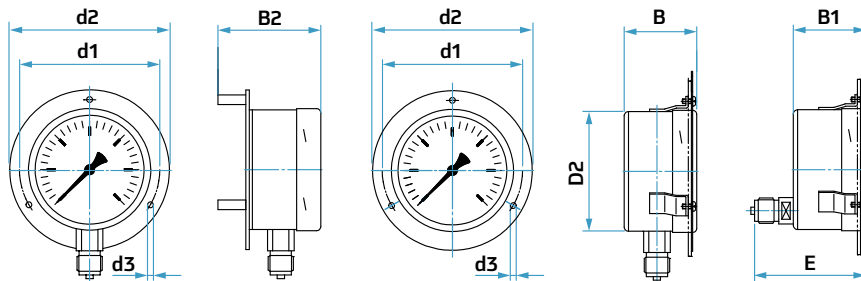

Case Size		B2		d1		d2		d3	
mm	inch	mm	inch	mm	inch	mm	inch	mm	inch
63	2/1 2	61	2.4	75	2.95	85	3.35	3.6	0.14
100	4	85	3.35	116	4.57	132	5.2	4.8	0.19
160	6	108	4.25	178	7.01	196	7.72	5.8	0.23



Process  
Pressure Gauges

# IMP P series



HAM-LET Industrial Mechanical  
Pressure Gauges

# IMPP series

## Data Sheet

### General

The Industrial **P** - Process pressure gauge is a heavy duty pressure gauge with special thermoplastic safety case for process industries, chemical, petro-chemical, gas and oil, power plant application in accordance in the ASME B40.1 standard.

The reinforced thermoplastic case and stainless steel wetted parts make the P pressure gauge suitable of service in corrosive areas and with aggressive media while maintaining the long life and durability for indoor and outdoor process applications.

The safety pattern case has a break-proof solid front (firm partition between the pressure element and the window) and a pressure relief back (blow-out back).

The P pressure gauge series is a bourdon tube mechanical devices, of case size 4½" (115 mm).

Suitable for vacuum to pressure up to 1,000 bar (15,000 psi).

### Features



- Thermoplastic case with back mounting design
- Stainless steel wetted parts
- Adjustable pointer (Micro pointer) for easy adjustment
- Break-proof solid front case with blow-out back
- Safety laminated glass front
- Case is filled or fillable
- Case protection: IP 65
- Compliance to ASME B40.1 standard grade 2A
- Fire retardant and impact resistance according UL 94 V0
- **Measuring ranges**
  - Vacuum: 30" Hg Vac. to 0 psi (-1 to 0 bar)
  - Compound: 30" Hg Vac. through 0 to 300 psi (-1 through 0 to 15 bar)
  - Pressure: 0 to 15,000 psi (0 to 1,000 bar).



## Materials of Construction

Part	Material	
<b>Wetted Parts</b>	Process connection	SS 316L
	Bourdon tube	
<b>Case</b>		Thermoplastic PBTP Black
<b>Window</b>		Laminated safety glass
<b>Movement</b>		Stainless Steel
<b>Dial</b>		Aluminum (black figures, white background)
<b>Pointer</b>		Aluminum (black)

## Technical Data - P Series

<b>Case Size</b>		4½" (115 mm)
<b>Accuracy</b>	<b>Up to 15,000 psi (1000 bar) (2)</b>	<b>±0.5% of span</b> EN 837-1 Class 1.0 ASME B40.1 Grade 2A
<b>Case Configurations</b>	<b>Process connection position</b>	
	<b>Built in Mounting</b>	
<b>Process Connection</b>	½", 12mm Tube adapter	+
	½" BSP-P/NPT	+
	¼" BSP-P/NPT	+
<b>Blow-Out Device</b>	Blow-out back	+
<b>Compensation Diaphragm</b>	By blow-out device / Plug	+
	Internal Elastomer	+
<b>Weight (1)</b> Pound (Kg.)	Unfilled	1.88 (0.85)
	Filled	2.76 (1.25)

(1) Approx. without mounting device

(2) See maximal pressure per connection type, page 6

## Configuration and Mounting Dimensions

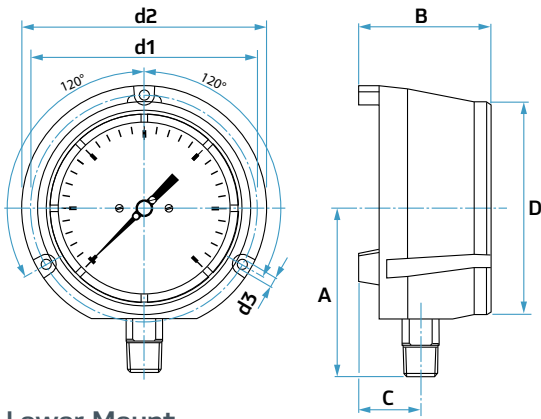

Lower Mount

Case Size		A		B		C		D		d1		d2		d3	
mm	inch	mm	inch	mm	inch	mm	inch	mm	inch	mm	inch	mm	inch	mm	inch
115	4 1/2	102	4.02	80	3.15	375	1.48	129	5.08	137	5.39	148	5.83	6.1	0.24





Low Pressures  
Pressure Gauges

# IMPL series





# IMPL series

## Data Sheet

### General

The Industrial L - Low pressures gauge series is a gaseous media positive and negative low pressure measurement devices with long usability and durability for indoor, outdoor and harsh surroundings, industrial, instrumentation and process applications.

The L series is a capsule mechanical device, Case sizes 63, 100, 160mm (2½", 4", 6") suitable for vacuum to pressure up to 250 inc H2O (600 mbar).

### Features

- All stainless steel case and wetted parts
- Bayonet ring
- Front-sided screw for zero point adjustment with an adjusting range of ±5%.
- Case is filled or dry
- Case protection: IP 54
- **Measuring ranges**
  - Vacuum/ Pressure: 0-1incH2O up to 0-250incH2O (0-2.5mbar up to 0-600mbar)
  - For case size 63mm (2½") 0-25incH2O (0-25mbar) and up
  - Compound: -0.4-06incH2O up to -150-100incH2O (-1-1.5mbar up to -400-200mbar)
  - For case size 63mm (2½") -4-6incH2O (-10-15mbar) and up

### Materials of Construction

Part		Material
<b>Wetted parts</b>	Process connection	SS 316L
	Bourdon tube	
<b>Case</b>		SS 304L
<b>Window</b>		Laminated safety glass
<b>Movement</b>		Stainless Steel
<b>Dial</b>		Aluminum (black figures, white background)
<b>Pointer</b>		Aluminum (black)



## Technical Data - L Series

Case Size		63mm (2½")	100mm (4")	160mm (6")
<b>Accuracy</b>		±1.6% of span EN 837-1 Class 1.6 ASME B40.1 Grade B	±1.6% of span EN 837-1 Class 1.6 ASME B40.1 Grade 1A	±1.6% of span EN 837-1 Class 1.6 ASME B40.1 Grade 1A
<b>Case Configurations</b>	<b>Process connection position</b>			
	<b>Mounting device (Optional)</b>			
<b>Process Connection</b>	½", 12mm Tube adapter			
	¾", 10mm Tube adapter			
	¼", 6mm Tube adapter			
	½" BSP-P/NPT		+	+
	¼" BSP-P/NPT	+	+	+
	⅛" BSP-P/NPT	+		
	M20x1.5		+	+
M12x1.5	+	+	+	
<b>Case Ventilation Filled Only</b>	By blow -out device		+	
<b>Weight <sup>(1)</sup></b> Pound (Kg.)	Unfilled	0.44 (0.20)	1.32 (0.60)	2.20 (1.00) <sup>(2)</sup>
	Filled	0.57 (0.26)	2.09 (0.95)	3.97 (1.80) <sup>(2)</sup>

(1) Approx. without mounting device.

(2) For 160mm (6") ≥ 25mbar - Unfilled 2.09 (0.95), Filled 3.97 (1.80).

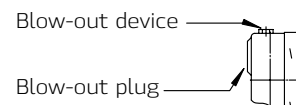

## Configuration and Mounting Dimensions

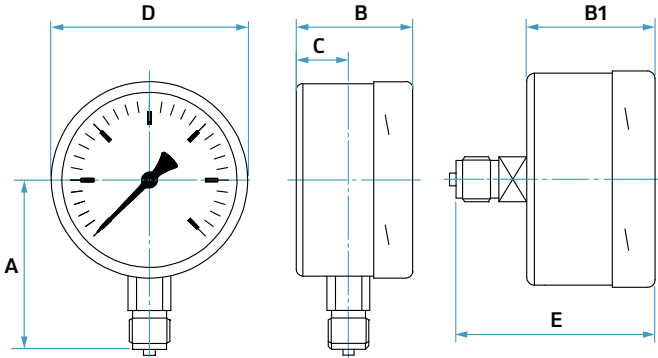

Lower Mount

Lower Back Mount

Case Size		A		B		B1		C		D		E	
mm	inch	mm	inch	mm	inch	mm	inch	mm	inch	mm	inch	mm	inch
63	2½	54	2.13	38 <sup>(1)</sup>	1.5 <sup>(1)</sup>	37	1.46	10	0.4	64	2.52	60	2.36
100	4	87	3.43	55	2.17	55	2.17	20 <sup>(2)</sup>	0.79 <sup>(2)</sup>	101	3.98	85	3.35
160	6	115	4.53	55	2.17	55	2.17	15	0.59	161	6.34	85	3.35
≤6 inCH <sub>2</sub> O (16mbar)				51	2.01	51	2.01	15	0.59				
160	6	115	4.53	51	2.01	51	2.01	15	0.59	161	6.34	81	3.18
≥10 inCH <sub>2</sub> O (25mbar)													

### Back Flange Mounting

### Front Flange Mounting

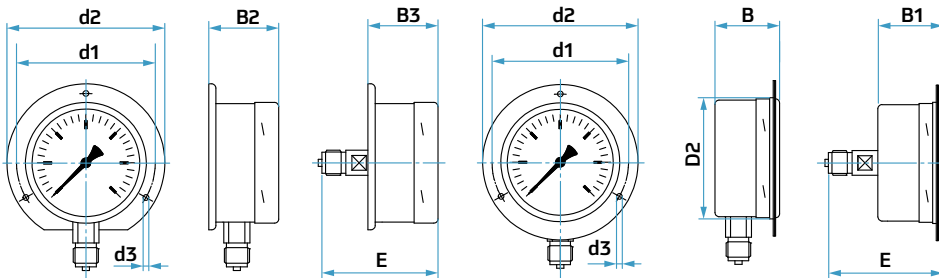

Case Size		B2		B3		D2		d1		d2		d3	
mm	inch	mm	inch	mm	inch	mm	inch	mm	inch	mm	inch	mm	inch
63	2½	41 <sup>(1)</sup>	1.61 <sup>(1)</sup>	40	1.57	66	2.6	75	2.95	85	3.35	3.6	0.14
100	4	59	2.32	59	2.32	103	4.06	116	4.57	132	5.20	4.8	0.19
160	6	58	2.28	58	2.28	163	6.42	178	7.01	196	7.72	5.8	0.23
≤6 inCH <sub>2</sub> O (16mbar)													
160	6	54	2.13	54	2.13	163	6.42	178	7.01	196	7.72	5.8	0.23
≥10 inCH <sub>2</sub> O (25 mbar)													

(1) For case size 63 filled: B=47 mm (1.85 inch), B2=50 mm (1.97 inch)

(2) For range ≤ 6 inCH<sub>2</sub>O (16mbar): C=15.5 mm (0.61 inch)

## Ordering Information For Industrial Mechanical Pressure Gauges

**OPTIONAL**

See page 29

**IMP** - Industrial Mechanical Pressure Gauge

**H** - Series

Gauge size	
mm	inch
40	1½
50	2
63	2½
10	4
11	4½
16	6

**10** - Gauge size

**L** - Process Connection Type

Process Connection Type	
Connection type	Connection Size
<b>P</b> - BSP-P	1/8, 1/4, 1/2 inch
<b>N</b> - NPT	1/8, 1/4, 1/2 inch
<b>M</b> - Metric (Mx1.5)	12M, 20M mm
<b>T</b> - Tube adapter	06M, 10M, 12M mm 1/4, 3/8, 1/2 inch
<b>V</b> - Face Seal Male swivel	1/4 inch
<b>F</b> - Face Seal Female swivel	1/4 inch
<b>H</b> - High pressure Male	916 (9/16) inch
High pressure Female	1/4 inch 16m mm

**P** - Process

**1/4** - Gauge size

**N** - Mounting Device

Process Connection Location		
Code	Description	Diagram
<b>L</b>	Lower mount	
<b>B</b>	Lower Back mount	
<b>C</b>	Center Back mount	

**B** - Mounting Device

Dial Range Units*	
<b>B</b>	bar
<b>P</b>	psi
<b>M</b>	milibar
<b>K</b>	kPa
<b>I</b>	MPa
<b>H</b>	inH <sub>2</sub> O
<b>A</b>	psi/bar
<b>C</b>	psi/kPa
<b>D</b>	psi/kgf/cm <sup>2</sup>
<b>E</b>	bar/psi
<b>F</b>	MPa/bar
<b>G</b>	kPa/H <sub>2</sub> O
<b>T</b>	Meter
<b>L</b>	kgf/cm <sup>2</sup>
<b>O</b>	mm H <sub>2</sub> O
<b>S</b>	Atmosphere

**B** - Mounting Device

Case	
<b>D</b>	Dry
<b>E</b>	Fillable (Empty)
<b>G</b>	Glycerin (99%)
<b>L</b>	Low Temperature Glycerin (86%)
<b>S</b>	Silicon Oil

**P025** - Dial Range

**E** - Case

See Table page 28

**Dial Range**

See Table page 28

**\*Primary / Secondary units**

**Primary**  
Black outer scale, defines the gauge range

**Secondary**  
Red inner scale, corresponds with gauge range

## Ordering Information For Certification

Accuracy, Material and various standards conformance certifications are available for ordering.

**IMP** - Industrial Mechanical Pressure gauge

**C** - Certificate

**31** - Class

**M** - Category

**Blank** - Type

Class		Category		Type
<b>00</b>	General	<b>A</b>	Accuracy <sup>(3)</sup>	<b>Blank</b> - General
<b>21</b>	2.1 <sup>(1)</sup> - Pass / fail	<b>M</b>	Material <sup>(2)(4)</sup>	<b>GC</b> - GOST - Customs declaration Russia
<b>22</b>	2.2 <sup>(1)</sup> - Inspection	<b>S</b>	Standard conformance <sup>(5)</sup>	<b>GR</b> - GOST - R
<b>31</b>	3.1 <sup>(1)(2)</sup> - Test Results, Item approval	<b>T</b>	Quality Test	<b>TR</b> - GOST-Type Russia
				<b>TU</b> - GOST-Type Ukraine
				<b>TK</b> - GOST-Type Kazakhstan
				<b>S</b> - Standard conformance
				<b>BP600</b> - Up to 600 bar (10,000 psi) scale
				<b>BP01K</b> - Up to 1000 bar (15,000 psi) scale

**(1)** According EN10204 **(2)** Material certificate 3.1 is available for 63mm & up. **(3)** Per item (serial No.) **(4)** Per item type **(5)** Per order.

### Warning!

The system designer and user have the sole responsibility for selecting products suitable for their special application requirements, ensuring their safe and trouble-free installation, operation, and maintenance. Application details, material compatibility and product ratings should all be considered for each selected product. Improper selection, installation or use of products can cause property damage or personal injury.

## Dial Range Ordering Codes

H,G,S,P Series								
bar			psi			MPa		
Code	Min.	Max.	Code	Min.	Max.	Code	Min.	Max.
V001	-1	0	V001	30" Hg vac.	0	V000	-0.1	0.00
VP60	-0.6	0	C015	30" Hg vac.	15			
CP60	-1	0.6	C030	30" Hg vac.	30	CP06	-0.1	0.06
C1P5	-1	1.5	C060	30" Hg vac.	60	CP15	-0.1	0.15
C003	-1	3	C100	30" Hg vac.	100	CP30	-0.1	0.30
C005	-1	5	C160	30" Hg vac.	160	CP50	-0.1	0.50
C009	-1	9	C200	30" Hg vac.	200	CP90	-0.1	0.90
C015	-1	15				C1P5	-0.1	1.50
			P315	3	15			
PP21	0.2	1	P010	0	10			
PP60	0	0.6	P015	0	15			
P001	0	1				PP10	0	0.1
P1P6	0	1.6	P030	0	30	PP16	0	0.16
P2P5	0	2.5	P060	0	60	PP25	0	0.25
P004	0	4	P100	0	100	PP40	0	0.40
P006	0	6	P160	0	160	PP60	0	0.60
P010	0	10	P200	0	200	P001	0	1
P016	0	16	P300	0	300	P1P6	0	1.6
P025	0	25	P600	0	600	P2P5	0	2.5
P040	0	40	P800	0	800	P004	0	4
P060	0	60	P01k	0	1,000	P006	0	6
			P1k5	0	1,500			
P100	0	100	P02k	0	2,000	P010	0	10
P160	0	160	P03k	0	3,000	P016	0	16
P250	0	250	P04k	0	4,000	P025	0	25
			P05k	0	5,000			
P400	0	400	P06k	0	6,000	P040	0	40
			P10k	0	10,000			
P600	0	600				P060	0	60
P01k	0	1,000	P15k	0	15,000	P100	0	100

L Series								
Milibar			kPa			in H2O		
Code	Min.	Max.	Code	Min.	Max.	Code	Min.	Max.
V600	-600	0						
			V050	-50	0	V200	-200	0
V400	-400	0						
V250	-250	0				V100	-100	0
			V020	-20	0			
V160	-160	0						
			V015	-15	0	V060	-60	0
V100	-100	0						
			V007	-7	0	V030	-30	0
V060	-60	0						
			V005	-5	0	V020	-20	0
V040	-40	0	V004	-4	0	V015	-15	0
V025	-25	0						
V016	-16	0						
V010	-10	0						
V006	-6	0						
V004	-4	0						
V2P5	-2.5	0						
C200	-400	200						
C400	-200	400						
C150	-250	150						
C250	-150	250						
C100	-150	100						
C115	-100	150						
C160	-100	60						
C610	-60	100						
C040	-60	40						
C060	-40	60						
C020	-40	20						
C240	-20	40						
C015	-25	15						
C025	-15	25						
C010	-15	10						
C105	-10	15						
P003	0	3						
P004	0	4						
P006	0	6						
P010	0	10						
P016	0	16						
P025	0	25						
P040	0	40	P004	0	4	P015	0	15
			P005	0	5	P020	0	20
P060	0	60						
			P007	0	7	P030	0	30
P100	0	100						
			P015	0	15	P060	0	60
P160	0	160						
			P020	0	20			
P250	0	250						
P400	0	400				P100	0	100
			P050	0	50	P200	0	200
P600	0	600						

## Options Ordering Codes

P		T		L		N		E		Y		6		X		R	
Additional Elements		Specials		Restriction Screw		Variations		Special Compatibility									
<b>Blank</b> None	<b>Blank</b> None	<b>Blank</b> None	<b>L</b> - Lubricant free	<b>Blank</b> None	<b>Blank</b> None	<b>Blank</b> None	<b>Blank</b> None	<b>Blank</b> None	<b>Blank</b> None	<b>Blank</b> None	<b>Blank</b> None	<b>Blank</b> None	<b>Blank</b> None	<b>Blank</b> None	<b>Blank</b> None	<b>Blank</b> None	<b>Blank</b> None
<b>P</b> - Fix Pointer	<b>T</b> - Measuring point SS Plate	<b>L</b> - Alloy 400 wetted parts	<b>N</b> - Helium leak test	<b>E</b> - Vibration resistant movement	<b>0</b> - Ø 0.0mm	<b>X</b> - Oxygen version	<b>G</b> - GOST - version	<b>3</b> - Ø 0.3mm	<b>W</b> - Pure gases	<b>R</b> - GOST-T - Russia	<b>4</b> - Ø 0.4mm	<b>A</b> - Absolute pressure	<b>U</b> - GOST-T - Ukraine	<b>6</b> - Ø 0.6mm	<b>Z</b> - Grade 3A (ASME)	<b>K</b> - GOST-T - Kazakhstan	
<b>M</b> - Min/Max Pointer		<b>S</b> - Silicon free			<b>8</b> - Ø 0.8mm												

### Additional Elements

**Fix Pointer:** additional red pointer pointing to a designated pressure on the dial. The fix pointer does not move with the measured pressure changes and it is used to point a fixed measure on the dial for the user.

**Min/Max Pointer:** additional red pointer pointing to the minimal or maximal pressure that was pointed to by the gauge main pointer. The Min/Max pointer has a mechanism to reset its position to the initial read ("0" read). The Min/Max pointer moves with the main gauge pointer to the minimal or maximal pointing position and remains in this position when the pressure read is raised / drops respectively and it is used to point to the minimal / maximal pressure read over time.

**Material heat stamp:** is required whenever a Material certificate level 3.1 is requested to be supplied with the gauge. (See "Certification" for more information on Material certificate).

### Specials

**Lubricant free:** The gauge is specially cleaned to have no oil leftovers on its internals. The lubricant free gauge is marked with a  icon on its dial.

**Silicon free:** The gauge is specially cleaned to have no silicon leftovers on its internals.

**Alloy 400 wetted parts:** The gauge wetted parts are made of Alloy 400. Alloy 400 wetted parts are frequently used for measuring highly corrosive media. Other special wetted parts materials are available.

**Helium leak test:** The gauge is tested for leakage of up to  $10^{-9}$  mbar l/s using pressurized Helium.

### Restriction Screw

A restriction screw with the designated bore is installed at the gauge media inlet, the restriction screw installation

and firmly fixing is done at the manufacturing plant. The restriction screw is one mean of protecting the gauge from pulsating or temporary high pressures and it slows down the gauge pointer reaction to pressure changes. A gauge with a restriction screw should be more carefully checked for its inlet being free of blockage by particles, viscous media or other obstacles.

### Variations

**Oxygen version:** The gauge is specially made to be used for oxygen measurement.

### Special Compatibility

The Gauge is manufactured to be compatible to the designated standard or regulation. A special compatible gauge is marked as required by the designated standard.

### Mounting Device

**Rear Flange:** The metal flange on the back of the gauge case is used to firmly mount the gauge on a panel/wall or any other fixing. The back flange is a firmly welded part of the gauge case and it guarantees the best support for the gauge.

**Front Flange:** The metal flange on the front of the gauge case is used to firmly mount the gauge on a panel or any other fixing with a hole to host the gauge. The front flange is a firmly welded part of the gauge case and it guarantees the best support for the gauge.

**U-Clamp:** The metal U shaped clamped with two fixing bolts supports the gauge from the back side of a panel hosting the gauge.





## Accessories

### Flame Arrester (ATEX approved)

Flame Penetration Protection

#### Function

The Flame arrester avoids a flame penetration at deflagrations of potentially explosive vapor-air-resp. gas-air mixtures of explosion hazardous IIA, IIB and IIC in an upstreamed volume (e.g. pressure measuring instruments, chemical seals or similar).

#### Explosion Protection

The deflagration volume protection device corresponds as non-electrical equipment for potentially explosive areas with the harmonized norm DIN EN ISO 16852 "Flame Penetration Protection".

It is examined and approved as flame penetration protected at deflagration of flammable gases and liquids according to EC-Type Examination Certificate / Approval PTB 12 ATEX 4001 X Explosion Protection Class IIG IIC The corresponding marking according to ATEX 94/9/EG is made at a suitable position of the instrument.

#### Construction

as screw-adapter  
1/2" BSP-P internal x 1/2" BSP-P  
(others upon request)



HAM-LET  
ASTAVA  
Manifolds

### Pressure Gauge Cocks

#### Cocks Models

Class	DIN 16262		DIN 16263	
Type	M20x1.5	1/2" BSP-P	Test Flange 60x25x10mm (2.36x0.98x0.39 inch)	Test Connection Male Thread M 20x1.5
Process connection	Male thread M 20x1.5	Male thread 1/2" BSP-P		
Instrument Connection	Clamping sleeve female M20x1.5	Clamping sleeve female 1/2" BSP-P		
Nominal Pressure	PN 16			
Handle	Plastic			
Material	- Brass (Clamping sleeve alloy steel phosphatized) - Alloy steel - Stainless steel 316 (1.4571)			

#### Applications

Fluid or gaseous media resp. steam at temperatures between -10°C to +50°C ( 14°F to 122°F) ;  
For connecting to a pressure gauge with flat sealing ring EN 837 (DIN 16 258)

### Over Range Protector

The over range protector is a piston valve. The piston will remain in an "open" position as long as the pressure of the medium is lower than the back pressure imposed on the piston by the spring. As medium pressure accedes the spring back pressure the piston will move towards the spring and the piston valve closes. After the medium pressure decreases by approximately 25% below the set closing pressure, the valve opens and the spring force causes the piston to return to its original "open" position.

The over range protector has been designed to protect pressure gauges against a pressure overload higher than the measuring range. It allows putting several gauges with different pressure ranges in ascending stages and makes it possible to read even low ranges in a precise way, when the total range is in fact much higher.

The valves are not suitable for use as regulators.

**Models:** Brass, Stainless steel.

#### Available Ranges:

PSI	BAR
3-35	0.4-2.5
30-85	2-6
75-350	5-25
300-850	20-30
750-3600	50-250
3500-5800	240-400

## Pressure Gauge Valves

According to DIN 16270, DIN 16271 with Male Test Connection, and with Test Flange

### Valves Models

Versions	Type	Process connection	Gauge connection	Test connections
<b>DIN 16 270</b>	BSP-P	½" BSP-P male	adjusting nut ½" BSP-P female	M 20x1,5
	Metric	M20x1,5 male	adjusting nut M20x1,5 female	
<b>DIN 16 270</b> with fitting for gauge holder bracket	BSP-P	½" BSP-P male	turnable nut ½" BSP-P female	
<b>DIN 16 271</b>	BSP-P	½" BSP-P male	adjusting nut ½" BSP-P female	
	Metric	M20x1,5 male	adjusting nut M20x1,5 female	
<b>DIN 16 271</b> with fitting for gauge holder bracket	BSP-P	½" BSP-P male	turnable nut ½" BSP-P female	
<b>Similar to DIN 16 271</b> with test flange	BSP-P	½" BSP-P male	adjusting nut ½" BSP-P female	flange 60 x 25 x 10 mm

### Material of Construction

Versions		Brass	Alloy Steel	Stainless Steel
<b>All Models</b>	<b>Components:</b>	Material (DIN material numbers)		
	<b>Body</b>	Brass	SS (1.0460)	SS (1.4571)
	<b>Valve spindle</b>	SS (1.4104)		
	<b>Valve cone</b>	SS (1.4034 hardened)		
	<b>Packing</b>	PTFE	Graphite	PTFE
	<b>Union nut</b>	Alloy steel		
	<b>Adjusting nut</b>	Alloy steel		
	<b>Turnable nut</b>	Brass	Alloy steel	SS (1.4571)
	<b>Vent screw</b>	SS (1.4104)		
	<b>Hand wheel</b>	Plastic		
<b>Temperature rating</b>	-10 / + 120°C (14 / 248°F)		-40 / +200°C (-40 / +392°F)	

## Ball Shock Absorber

Ball shock absorber are designed to protect pressure instruments against heavy pressure impacts.

In case of pressure drops or pressure peaks the media moves the stainless steel ball within the inlet port and damps the appropriate bore.

The counter direction has free flow. In case of order it must be clarified if the ball shock absorber is used for pressure peaks (marked with + on the

body) or pressure drops (marked with - on the body)

### Construction

Made of 316L stainless steel or brass with male and female thread ½" BSP or NPT.

### Application

material test machines, hydraulic accumulators, hydraulic clamping devices



HAM-LET Industrial Mechanical  
Pressure Gauges



**HAM-LET USA**

12565 West Airport Blvd.  
Sugar Land, Texas 77478  
Tel: +1 281 5664900  
Fax: +1 281 5664910  
e-mail: usa@ham-let.com

**HAM-LET Germany**

Dornacher Strasse 3a  
D-85622 Feldkirchen  
Tel: +49 89 90778060  
Fax: +49 89 90778070  
e-mail: gmbh@ham-let.com

**HAM-LET Russia**

125319 Moscow, Chernyakhovskogo Str. 16,  
office 1100 Ham-Let LLC  
Tel: +7 495 6516238  
Fax: +7 495 6516238  
e-mail: russia@ham-let.com

**HAM-LET Canada**

3190 Ridgeway Drive, Unit 33  
Mississauga, Ontario, L5L 5S8  
Tel: +1 905 6089996  
Fax: +1 905 6088661  
e-mail: canada@ham-let.com

**HAM-LET France**

Siège Social, Park Avenir  
Zone de Sacuny  
Avenue Marcel Merieux  
bâtiment B7, 69530, BRIGNAIS  
Tel: +33 4 78950342  
Fax: +33 4 72310576  
e-mail: france@ham-let.com

**HAM-LET Singapore**

211 Woodlands Avenue 9 Spectrum II  
building #05-88  
Singapore 738960  
Tel: +65 62578313  
Fax: +65 62578315  
e-mail: singapore@ham-let.com

**HAM-LET UK**

Unit 1, Lindfield Enterprise Park  
Lewes Road, Lindfield  
Haywards Heath, West Sussex  
RH16 2LH  
Tel: +44 1444 487555  
Fax: +44 1444 487666  
e-mail: uk@ham-let.com

**HAM-LET BENELUX B.V.**

Industrieweg 30, 7944 HS,  
Meppel, The Netherlands  
Tel: +31 522237049  
Fax: +31 522237040  
e-mail: benelux@ham-let.com

**HAM-LET Motoyama Japan (HMJ)**

TSI Hakozaki Bldg. 4F,  
20-5, Hakozaki-cho, Nihonbashi,  
Chuo-ku, Tokyo, 103-0015  
Tel: +81 3 36685321  
Fax: +81 3 36647027  
e-mail: hmj@ham-let.com

